

JUVIVO







Item No. OC547-Fab-G3-1-GY

This product features an assembly design. Please follow the instructions below for proper assembly. All the necessary components listed below are included in the packaging.

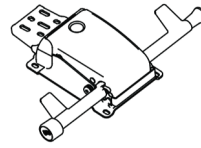
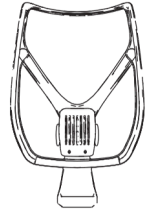
Final Assembly Diagram

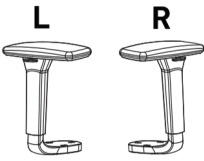
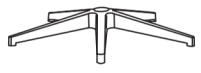
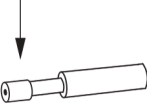

Parts

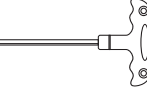
<p>A</p>  <p>x1</p>	<p>B</p>  <p>x1</p>	<p>C</p>  <p>x1</p>	<p>D</p>  <p>L R</p> <p>x2</p>
<p>Mechanism</p>	<p>Backrest</p>	<p>Seat Cushion</p>	<p>3D PU Armrest</p>
<p>E</p>  <p>x1</p>	<p>F</p> <p>Before assembling, take it out.</p>  <p>x1</p>	<p>G</p>  <p>x10+1</p>	<p>H</p>  <p>x3+1</p>
<p>Nylon Base</p>	<p>Gas Lift</p>	<p>Screw M6 x 1.38"</p>	<p>Screw M8 x 0.71"</p>
<p>I</p>  <p>x5</p>	<p>J</p> 		
<p>PU Wheel</p>	<p>T Shape Wrench</p>		

Assembly Steps

Before assembling this product, please read these instructions carefully

01 Installing Backrest

Connect Mechanism(A) to the Backrest(B) using 3 pcs screws(H).

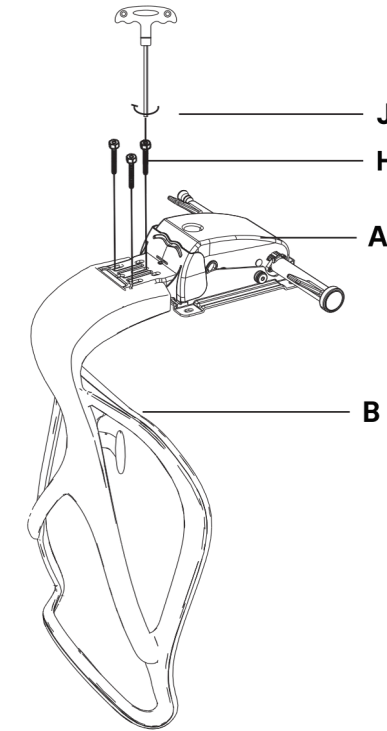

02 Installing Armrest to Seat Cushion

Connect 3D PU Armrest (D) to the Seat cushion (C) using 6 pcs screws(G).

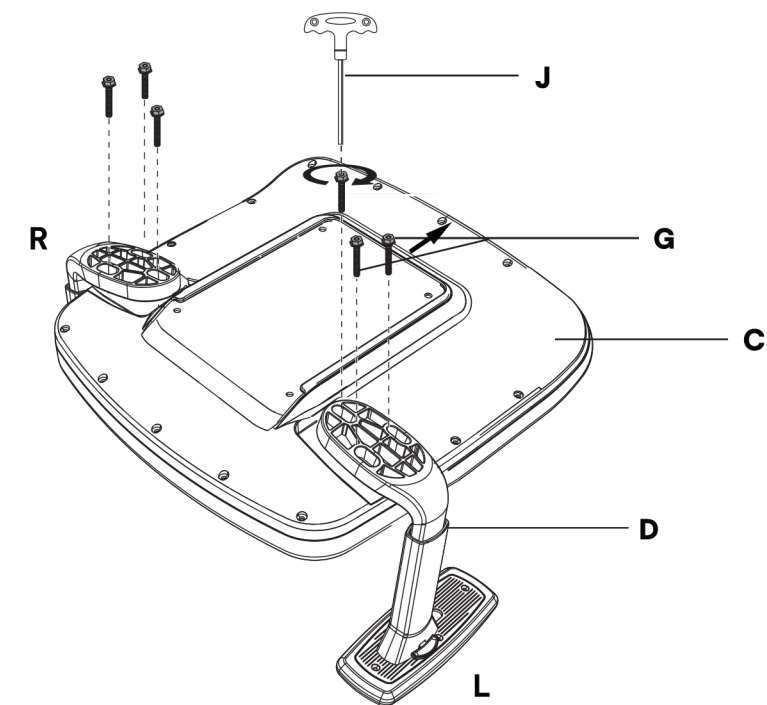

03 Attaching Backrest to Seat Cushion

Connect the Mechanism(A) to the seat cushion(C) using 4 pcs screws(G).

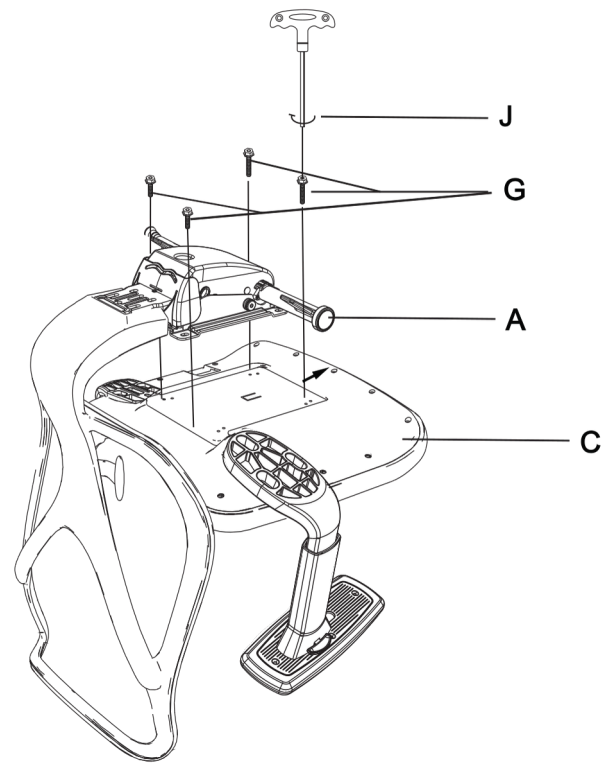

05 Installing the Chair Body on the Gas Lift F



04 Installing Gas Lift and Wheels to Nylon Base

Before assembly, taking out gaslift's cover from gas lift(F).

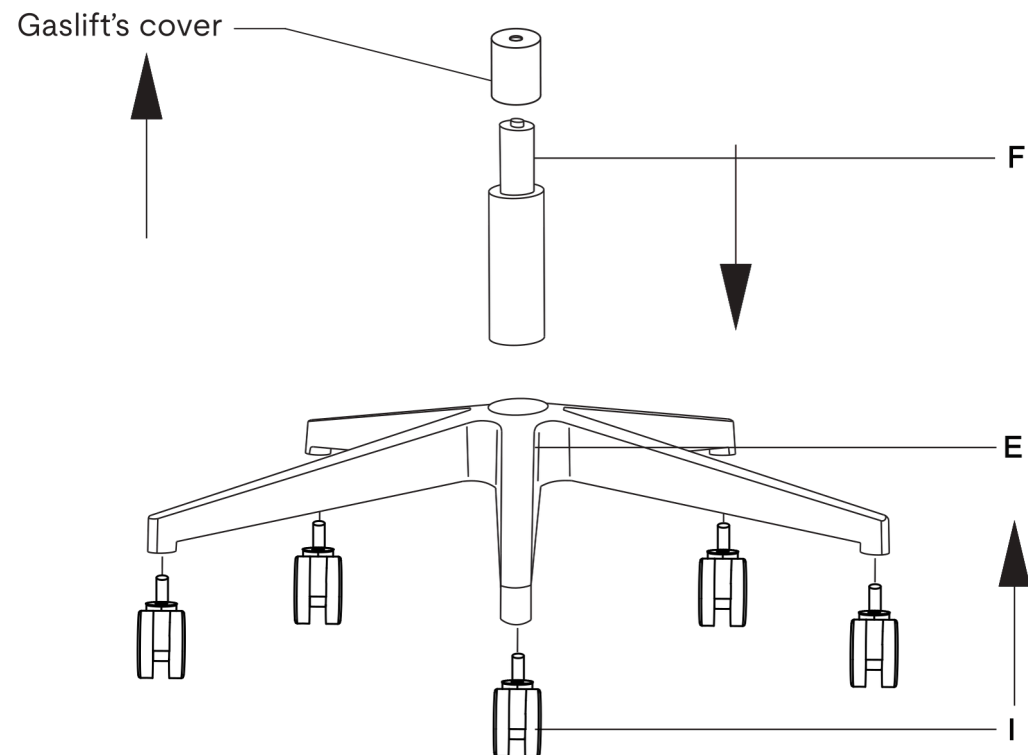

06 Installing Completed

